

**Sealing profiles**

# Catalogue extract

## General



GfA - DICHTUNGEN FÜR ALTBAUTEN UND SYSTEME  
JOACHIM HAGEMEIER GMBH

Hauptstraße 62 - 66  
D-21439 Marxen by Hamburg

Phone: +49 41 85 / 58 40-0  
Fax: +49 41 85 / 58 40-40

eMail: [info@gfa-dichtungen.de](mailto:info@gfa-dichtungen.de)  
<http://www.gfa-dichtungen.de>



**Catalogue extract:** General  
**General Issue:** 03/2010  
**© 2010:** GfA - DICHTUNGEN FÜR ALTBAUTEN UND SYSTEME JOACHIM HAGEMER GMBH  
**Design:** JMC Janss Marketing Consulting



## GfA – Dichtungen, a company with an image

Several decades of experience in development, construction and production make us the top tailoring company for sealing profiles in the market. As an owner-controlled family enterprise we personally stand for a dependable partnership.

Since our beginnings as a seals supplier for manufacturers of wooden windows and doors, we are subject to constant change. Product variety and areas of application have considerably increased over time. Today new mechanical and functional demands, special chemical durability and many unusual customer wishes determine our daily business. We therefore have several thousand sealing profiles for all kinds of application in stock.

Saving energy, lowering costs and protecting the environment have become a topic for us before the energy saving regulations came into effect. In the refurbishment of old buildings, the exchange of worn or mechanically or chemically of destroyed seals with state-of-the-art profiles, provide considerable economic and energetic savings.

Own tool construction, even for small series, modern production and personal care in the both office and field are the basis to successful complete even extraordinary projects in time.

Manufacturing seal corners or welding together complete seal frames, self-adhesive equipment of seals and many other packaging possibilities complete our offer.

We put special emphasis on personal, long-standing and trusting relationships with customers and suppliers.





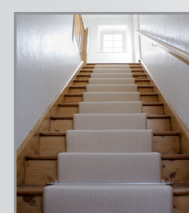





















### GfA-Dichtungen for:





Excerpt from our range of products | scale 1:1

			
SZ-001 gr., br., w.	SZ-030 gr., br., w.	SZ-027 gr., br., w.	SZ-166 gr., w.
			
SZ-080 gr., br.,w.	SZ-190 gr., w.	SZ-194 gr.	SZ-037 gr.
			
SZ-014-X gr., br., w.	SZ-197-X gr., w.	SZ-147-X gr., br., w.	SZ-032-X gr., br., w.
			
SZ-077 gr., br., w.	SZ-633 gr., w.	SZ-092-X gr., w.	SZ-423 gr., w.
			
SZ-010-X gr., br., w.	SZ-098-X gr.	SZ-093 gr.,bl.	SZ-050 gr., bl., w.
			
SZ-019-X gr., w.	SZ-537 gr.	SZ-022 gr.	SZ-055 gr.

**Abbreviations for standard colours:**

tr: = transparent  
 w: = white  
 b: = beige  
 br: = brown  
 gr: = grey  
 bl: = black

**Materials:**





















Sealing profiles with the classification letter SZ are made of TPE but for few exceptions. These exceptions are marked.

**Note:**

The minimum amount for stock profiles = 10 m, other amounts must be divisible by 5 m. Profiles without colour information are available upon enquiry. Exchange and return are not possible. Please ask for samples before ordering, if required. Technical changes may occur.

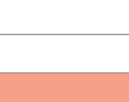
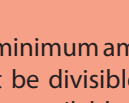

Excerpt from our range of products | scale 1:1

	SZ-094 gr., b., w.		SZ-122 gr.		SZ-066 gr., w.		SZ-048 gr., w.
	SZ-057 gr., br., b. w.		SZ-011 gr., br., w.		SZ-025 gr., w.		SZ-035 gr., w.
	SZ-005 gr., br., w.		SZ-018 gr., w.		SZ-068 gr., w.		SZ-072 gr.
	SZ-201-X gr., w.		SZ-202-X gr., w.		SZ-206-X gr.		SZ-458-X gr., w.
	Foam rubber square profiles Silicone foam square profiles also with self-adhesive coating				Rubber U profiles		
	Foam rubber round cords Silicone foam round cords Rubber round cords				Rubber angle profiles		
					Rubber square profiles		
					Rubber tube profiles		
					Rubber round cords		

### Abbreviations for standard colours:

tr: = transparent  
w: = white  
b: = beige  
br: = brown  
gr: = grey  
bl: = black

### Materials:

























Sealing profiles with the classification letter SZ are made of TPE but for few exceptions. These exceptions are marked.

### Note:

The minimum amount for stock profiles = 10 m, other amounts must be divisible by 5 m. Profiles without colour information are available upon enquiry. Exchange and return are not possible. Please ask for samples before ordering, if required. Technical changes may occur.

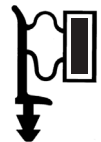

Excerpt from our range of products | scale 1:1

			
ADTP-401-V w., gr., br., b., bl.	ADTP-433-V w., gr., br., b., bl.	ADTP-912 w., gr., br., b., bl.	ADTP-410 w.
			
ADTP-1427 w., gr., br., b.	ADTP-427 w., gr., br., b., bl.	ADTP-440 w., gr., br., b.	ADTP-546 w., br.
			
ADTP-1517 bl.	ADTP-442 br., w.	ADTP-426 br., w.	ADTP-562 w.
			
ADTP-423 w., br., gr.	ADTP-424 w., br.	ADTP-439 w., br., b.	ADTP-615 w., br.
			
ADÜTP-496 w., b., br., bl.	ADTP-1416 w.	ADTP-1408 w., b., br.	ADTP-435 bl.
			
ADTPHH-1774 bl., br.	ADHH-1490 w., br.	ADTP-060 bl.	ADTP-176 bl.

**Abbreviations for standard colours:**

tr: = transparent  
w: = white  
b: = beige  
br: = brown  
gr: = grey  
bl: = black

**Materials:**

























Sealing profiles with the classification letter SZ are made of TPE but for few exceptions. These exceptions are marked.

**Note:**

The minimum amount for stock profiles = 10 m, other amounts must be divisible by 5 m. Profiles without colour information are available upon enquiry. Exchange and return are not possible. Please ask for samples before ordering, if required. Technical changes may occur.



Excerpt from our range of products | scale 1:1

			
ADTP-1230 w., gr., br., b., bl.	ADTP-215 w., br., bl.	AD-048 tr.	ADTP-1436 w., br., bl.
CUSHION seal 10-4-X	CUSHION seal 12-5-X	CUSHION seal 15-5-X	CUSHION seal 18-5-X
			
ADTP-838 bl.	ADTP-834 w., gr., br., b., bl.	ADTP-835 w., br., bl.	ADTP-833 w., bl.
			
ADÜTP-874 bl.	ADÜTP-1248 w., br., bl.	ADÜTP-1551 w., br., bl.	ADÜTP-1851 w., bl.
			
ADTPVB-1250 w., bl.	ADTP-1541 w., br., bl.	ADTP-1502 w., br., bl.	ADSL-1852
			
ADTP-076 w.	ADTP-100 bl.	ADTP-2017 gr.	ADTP-365 bl.
			
ADTP-038 bl.	ADTP-043 gr., bl.	ADTP-131 bl., gr., w.	ADTP-471 bl.

**Abbreviations for standard colours:**

tr: = transparent  
 w: = white  
 b: = beige  
 br: = brown  
 gr: = grey  
 bl: = black

**Materials:**











Sealing profiles with the classification letter SZ are made of TPE but for few exceptions. These exceptions are marked.

**Note:**

The minimum amount for stock profiles = 10 m, other amounts must be divisible by 5 m. Profiles without colour information are available upon enquiry. Exchange and return are not possible. Please ask for samples before ordering, if required. Technical changes may occur.



Excerpt from our range of products | scale 1:1

Illustration 1:1	Type no. <b>ADSL</b>	Outside of tuben-ø	Colour	Illustration 1:1	Type no. <b>ADSL</b>	Outside of tube-ø	Colour
	1005	5	white brown		1013	10 hoch	white
	1009	6,5	white brown grey				
	1011	8	white brown grey		1024	8	white brown grey
	1006	6	white brown				
	1008	8	white brown		1020	8	
	1010	10	white brown		1021	10	

**Note::**

From a minimum order value of 30€, mixed for types, there is no delivery charge, including packaging. Exchange and return are not possible. Please ask for samples before ordering, if required. Technical changes may occur.





Excerpt from our range of products | scale 1:1

Illustration	Type	Material	for gap from mm	width of foot in mm	Colour	Form of delivery	Design
	EVERYWHERE seal ADSL-2001 self-adhesive	silicone rubber	1,4	7,5	white brown black	reels of 50m or self-service stack of 5m	 double rope profile
	DROP seal ADSL-447 self-adhesive	silicone rubber	1,4	7,5	white black	reels of 50m or	 double rope profile
	OMEGA seal ADSL-1024 self-adhesive	silicone rubber	-	8	white black brown	reels 100m or self-service stacks of 12m	see picture to the left
	ADTP-1962 self-adhesive	TPE	-	8,5	white black brown	reels 100m or self-service stacks of 12m	 double rope profile
	DOUBLE seal ADEPS-537 self-adhesive	EPDM rubber	2,4	10,0	white brown	reels of 100m or self-service stack of 10m	 double rope profile
	TANDEM seal ADEPS 550 self-adhesive	EPDM rubber	2,4	11,5	white brown	reels of 100m	 double rope profile
	BRUSH seal ADTSK-1000 self-adhesive	Hard PVC/ synthetic-Flor	to 12 mm	-	white brown transparent	self-service stack of 1m	see picture to the left

**Note:**

From a minimum order value of 30€, mixed for types, there is no delivery charge, including packaging. Exchange and return are not possible. Please ask for samples before ordering, if required. Technical changes may occur.

Excerpt from our range of products | scale 1:1

	ADTP-171	bl.		ADTP-231	bl., w.		ADTP-359	bl.		ADTP-2042	gr.
	AD-023	tr.		ADTP-223	bl.		ADHH-791	bl.		ADTP-129	w.
	ADTP-012	bl.		ADTP-651	bl.		ADTP-1352	w., bl.		ADTP-1353	w., bl.
	ADTP-157	bl.		ADTP-152	bl.		ADTP-145	bl.		ADTP-1628	bl.
	ADTP-121	bl.		ADTP-057	bl.		ADTP-1205	bl.		ADTP-351	bl.
	ADTP-1233	bl.		ADTP-1207	bl.		ADTP-360	bl.		ADTP-1246	gr., bl.

**Abbreviations for standard colours:**

tr: = transparent  
w: = white  
b: = beige  
br: = brown  
gr: = grey  
bl: = black

**Materials:**

Sealing profiles with the classification letter SZ are made of TPE but for few exceptions. These exceptions are marked.

**Note:**

























The minimum amount for stock profiles = 10 m, other amounts must be divisible by 5 m. Profiles without colour information are available upon enquiry. Exchange and return are not possible. Please ask for samples before ordering, if required. Technical changes may occur.

# Sealing profiles

System windows and doors made of plastic, wooden aluminium, aluminium and steel – glazing



Excerpt from our range of products | scale 1:1

	ADSL-981	bl.		ADTP-159	bl.		ADTP-261	bl.		ADTP-1256	bl.
	ADTP-760	bl.		ADTP-253	bl.		ADTP-747	bl.		ADTP-258	bl.
	ADTP-605	bl.		ADTP-1259	bl.		ADTP-1560	bl.		ADSL-1832	bl.
	ADTP-264	bl.		ADTP-272	bl.		ADTP-271	bl.		ADTP-723	bl.
	ADTP-195	bl.		ADTP-594	bl.		ADTP-1603	bl.		ADTP-713	bl.
	ADTPHH-551	bl.		ADTP-888	bl.		ADTP-181	bl.		ADTPHH-937	bl.

## Abbreviations for standard colours:

tr: = transparent  
 w: = white  
 b: = beige  
 br: = brown  
 gr: = grey  
 bl: = black



## Materials:

Sealing profiles with the classification letter SZ are made of TPE but for few exceptions. These exceptions are marked.

## Note:

The minimum amount for stock profiles = 10 m, other amounts must be divisible by 5 m. Profiles without colour information are available upon enquiry. Exchange and return are not possible. Please ask for samples before ordering, if required. Technical changes may occur.

Excerpt from our range of products | scale 1:1

	ADTP-006	bl.		ADTP-318	bl.		ADTP-1038	bl.		ADTP-030	gr.
	ADTP-545	w.,bl.		ADTP-769	bl.		ADTP-577	bl.		ADTP-741	bl.
	ADTP-625	bl.		ADTP-341	bl.		ADTP-887	bl.		ADTP-1362	bl.
	ADTP-624	bl.		ADTP-1571	bl.		ADTP-1511	bl.		ADTP-705	bl.
	ADTP-357	bl.		ADTP-1267	bl.		ADTP-1548	bl.		ADTP-849	bl.
	ADTP-2091	bl.		ADTP-2179	bl.		ADTP-2265	bl.		ADTP-678	bl.

**Abbreviations for standard colours:**

tr: = transparent  
w: = white  
b: = beige  
br: = brown  
gr: = grey  
bl: = black

**Materials:**













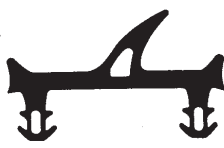

Sealing profiles with the classification letter SZ are made of TPE but for few exceptions. These exceptions are marked.

**Note:**

The minimum amount for stock profiles = 10 m, other amounts must be divisible by 5 m. Profiles without colour information are available upon enquiry. Exchange and return are not possible. Please ask for samples before ordering, if required. Technical changes may occur.

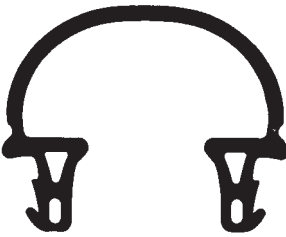

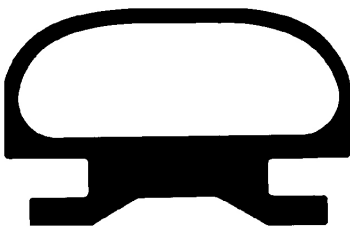
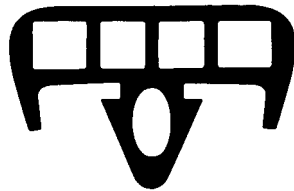
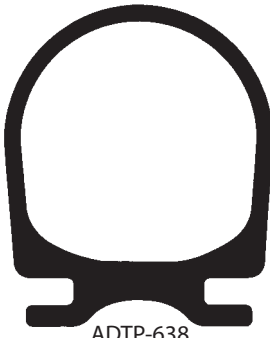
Excerpt from our range of products | scale 1:1

 ADTP-943	bl.	 ADTP-1559	bl.	 ADTP-317	bl.	 ADTP-520	bl.
 ADTP-1282	bl.	Not to scale  ADTP-850	bl.	 ADTPHH-1704	bl.	 ADHH-1739	bl.
Stairs anti-slip  ADHH-1438	bl.	Stairs anti-slip  ADHH-1414	bl.	Conservatory profiles 			
 ADTP-871	bl.	 AD-494	bl.	 ADTP-663	bl.	 AD-712	bl.
 ADTP-638		 AD-453		 ADTP-2242			

**Abbreviations for standard colours:**

tr: = transparent  
w: = white  
b: = beige  
br: = brown  
gr: = grey  
bl: = black

**Materials:**

Sealing profiles with the classification letter SZ are made of TPE but for few exceptions. These exceptions are marked.

**Note:**

The minimum amount for stock profiles = 10 m, other amounts must be divisible by 5 m. Profiles without colour information are available upon enquiry. Exchange and return are not possible. Please ask for samples before ordering, if required. Technical changes may occur.



Excerpt from our range of products | scale 1:1

GB-400 Corner tongs to unlatch casement seals



GB-405 Bevelling shears for 45° cuts



GB-406 Ambo shears



GB-410 Burring tongs



GB-421 Superglue 20 g  
GB-422 Superglue 50 g  
GB-425 Primer 10ml too ditto



GB-423 Glue Flex 310 M  
Glue and sealant  
GB-424 Silicone glue



GB-420 lubricant for the installation and care of seals of all kind



Excerpt from our range of products | scale 1:1

**GB-150 punch 3**, fig. with punch stamp 7 (GB-156), blades (GB-159) and cut core standard (GB-151)



Welding cores



Working sections

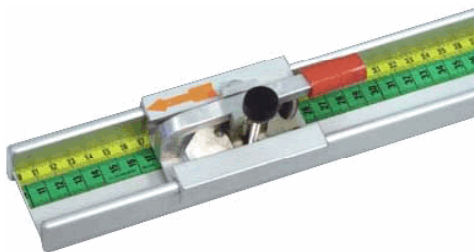

Inserting device for window seals



Inserting device for door seals



**GB-100 seal welding apparatus HSG-3**, fig. with fan / smoke de-duction (GB-101) and welding core



Cut core



Spare parts



Blades for tongs and punches



Inserting device for mill seals





Excerpt from our range of products | scale 1:1

	<p><u>6-8 mm ESG</u> ADZH-1760 tr 2010 mm ADZH-1760 tr 2500 mm</p> <p><u>10-12 mm ESG</u> ADZH-1766 tr 2200 mm ADZH-1766 tr 2500 mm</p>		<p>Set 180°</p> <p><u>6-8 mm ESG</u> 2 x ADZH-1750 tr NS or SN</p> <p><u>10-12 mm ESG</u> 2 x ADZH-1776 tr NS or SN</p>
	<p><u>6-8 mm ESG</u> ADZH-1768 tr 2010 mm ADZH-1768 tr 2200 mm ADZH-1768 tr 2500 mm</p> <p><u>10-12 mm ESG</u> ADZH-1777 tr 2200 mm ADZH-1777 tr 2500 mm</p>		<p>Set 90°</p> <p><u>6-8 mm ESG</u> 1 x ADZH-1750 tr NS and 1 x ADZH-1750 tr SN</p> <p><u>10-12 mm ESG</u> 1 x ADZH-1776 tr NS and 1 x ADZH-1776 tr SN</p>
	<p><u>6-8 mm ESG</u> ADZH-1779 tr 2010 mm ADZH-1779 tr 2500 mm</p>		<p><u>6-8 mm ESG</u> ADZH-1751 tr 2010 mm ADZH-1751 tr 2200 mm ADZH-1751 tr 2500 mm</p> <p><u>10-12 mm ESG</u> ADZH-1775 tr 2200 mm ADZH-1775 tr 2500 mm</p>
	<p>ADZH-1758 tr 2010 mm ADZH-1758 tr 2500 mm</p>		<p><u>6-8 mm ESG</u> ADZH-1753 tr 2010 mm ADZH-1753 tr 2500 mm</p>
	<p>ADZH-1796 tr 2010 mm ADZH-1796 tr 2500 mm</p>		<p><u>6-8 mm ESG</u> ADZH-1770 tr 2010 mm ADZH-1770 tr 2500 mm</p> <p><u>10 mm ESG</u> ADZH-1771 tr 2500 mm</p>
	<p>ADZH-1799 light-grey Yard goods self-adhesive</p>		<p><u>6-8 mm ESG</u> ADZH-1756 tr 2010 mm ADZH-1756 tr 2500 mm</p> <p><u>10 mm ESG</u> ADZH-1757 tr 2500 mm</p>

## ABOUT THE RENEWAL AND RENOVATION OF WINDOWS AND DOORS

**O**f outside windows and doors, cause great energy losses.

A huge number of buildings are still totally or partly equipped with single-glazed windows or the sealing profiles in the existing double-glazed windows have become worn out and useless over time. Outside doors with little insulated glass and frame materials have also been made.

These „old“ construction elements subsequently cause high energy losses and provide, in addition, an uneasy residential climate and, perhaps, also an increased noise pollution. With low outside temperatures the windowpanes cool down to degrees below zero and thus unilaterally take away heat from the rooms.

Sealing profiles are wear and tear articles; they are subject to huge thermal stress over the years, often unnoticed, and thus wear out with time. Depending on the stress put on the seal, these „old“ seals should be exchanged after 7 to 15 years. The exchange of old seals with new functioning ones again helps you in lowering your energy costs.

We recommend that you have this work done by an expert, who possibly also services the construction elements. He will be able to also discuss the necessary energy identity card in case you have a change tenant or are thinking of selling or bigger rebuilding measures.

By renewing insufficient sealing profiles:

- energy loss is clearly reduced
- residential comfort increases
- the sound insulation is improved
- it is a step on the way to the energy passport

The accompanying colour isotherm representation makes clear how with today's heat insulation glazing, new sealing profiles and plastic glass distance holders, the thermal bridge is moved outside.

**Saving energy mean saving the environment**

**L**ittle effort - can have quite a big effect.

**Do you save – or still use heating?**

Who can really afford such waste of energy these days?

Only is only that most people think that it only happens to the neighbours.

A mistake that can cost you.

Just have a thermal picture taken of your house.

**If looks like this - then you must act!**

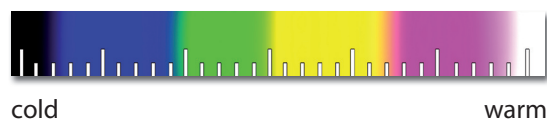
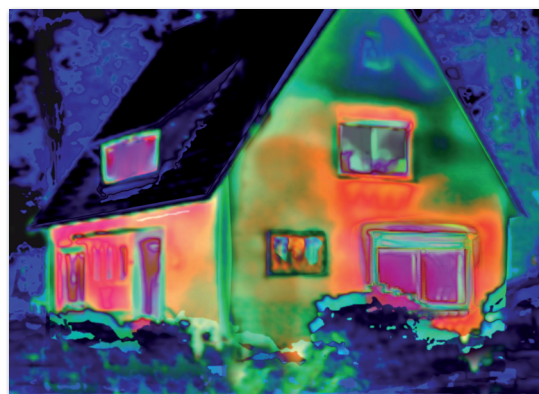

## OUR SERVICE

### **Which sealing profile?**

Who knows the names of all seals? No problem, simply cut off a piece of the old sealing profile and send in it to us for assessment. We do the rest for you.

### **New tools**

We don't have the profile you need? Impossible. From 200m we build a new tool at a reasonable price, fitted to your use.

### **Storage**

We always have several thousand seals from our huge range in stock for you. Delivery is next day. If a profile is sold out, it is made short-term, i.e. within a few days.



- This is how you order completely welded seal frames for wooden window and doors and for middle seals of system windows, of aluminium, wooden aluminium, plastic and steel fast and simply.
- Insert your firm stamp / sender in - **field 1**, with information of a contact for possible further enquiries. Please state your customer number.
- Put down in - **field 2** your seal type. Should you not exactly know the type, there are two possibilities:
  - Make a stamp impression of your required seal in **field 2a**, or
  - Send in to us your pattern for assessment
- Put down in - **field 3** your colour wish
- Mark in - **field 4** the frame kind
- Put down in - **field 5** your positions with amount, width measure and height measure.
- Mark in - **field 6** the frame type (4-sided or 3-sided) for wooden window seals

## Principle drawings for relation measures

### Measuring points in the casement – wooden window

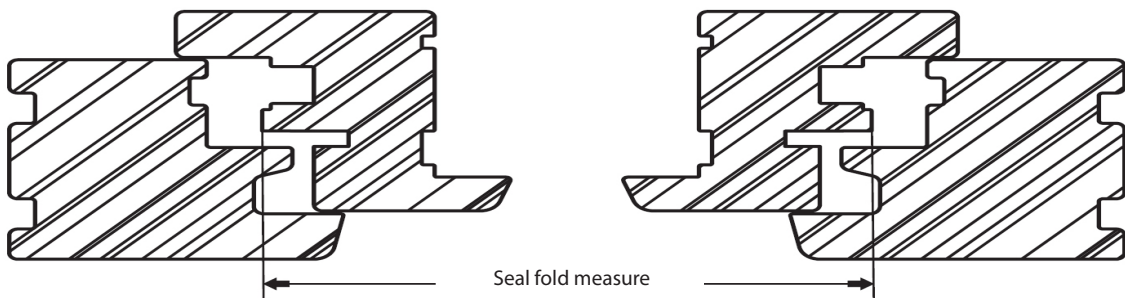

### Measuring points in the window frame

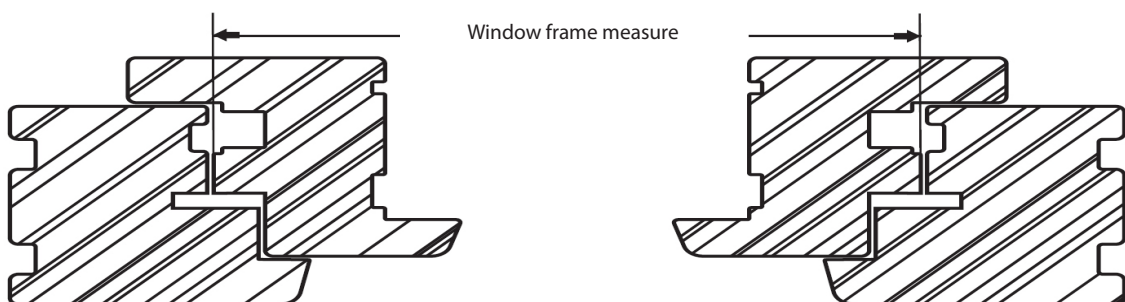

### Measuring points with middle seals

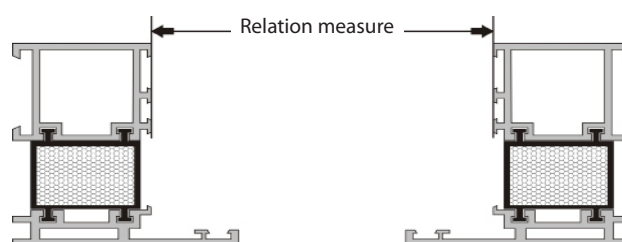



## Order form

1. Field for your sender stamp with phone and fax number	Customer no.:	
	Contact person:	
	Date:	
	Order no.:	

2. Type of seal:	2a. Impression of sealing profile:
3. Colour:	

4. Type of frame:

Seals for casements/wooden  
  Seals for window frames/wood  
  Centre seal for system windows

5. Measurements				6. Please tick for wooden windows		
Pos.	Piece	Width/mm	Height/mm			

**Sender**

<i>Company stamp (legible please)</i>	Date: _____ Contact person: _____ Phone: _____ Fax: _____ Email: _____
---------------------------------------	--

**Working model**

Please first send me a working model (ca. 10cm) of the seal shown below as a trial sample.

Please send me a working sample of: \_\_\_\_\_

**Seal,** easily done – simply make a stamp impression or send in the pattern for evaluation.

Amount:	Article (stamp mark):	Colour:	Is filled in by GfA-Dichtungen upon receipt of query
_____m/pc.			Price p. meter/piece in €:

**Special corners,** the Windows are not always airtight with yard goods alone. You need either welded seal frames (see pages 18 and 19) or special corners. These are inserted first, then the yard goods are inserted with approx. 1% of addition. The splicings are glued together with our primer (GB-425) and special glue (GB-421 or GB-422).

Amount:	Article:	Is filled in by GfA-Dichtungen upon receipt of query
_____pc.	Casement: <input type="checkbox"/> Window frame: <input type="checkbox"/>	Price p. piece in €:

**Accessories**

Amount:	Article:	Is filled in by GfA-Dichtungen upon receipt of query
_____pc.		Price p. piece in €:

\_\_\_\_\_ Date / signature