









Zum Austauschen



			
ADTP-255	ADTP-1046	ADTP-2043	
			
ADSL-966	ADTP-772	AD-1590	
			
ADSL-985			
			
AD-1531	AD-1072		

Abkürzungen der Standardfarben:

tr.: = naturtransparent
 wß.: = weiß
 b.: = beige
 br.: = braun
 gr.: = grau
 sw.: = schwarz



















Abkürzungen der Werkstoffe:

AD: = Elastisch-PVC
 ADHH: = Halbhart-PVC
 ADTP: = TPE
 ADTPHH: = Halbhart-TPE
 ADSL: = Silicon-Kautschuk

Wichtige Hinweise:

Mindestmenge bei Lagerprofilen = 10 m, weitere Mengen müssen durch 5 m teilbar sein. Ab Mindestauftragswert von 30,- €, nach Typen gemischt, erfolgt Lieferung frei Haus, einschließlich Verpackung. Profile ohne Farbangebe auf Anfrage. Umtausch und Rückgabe ausgeschlossen. Bei Bedarf vor Bestellung bitte Muster anfordern. Technische Änderungen vorbehalten.

Kantenschutz- und Dichtungsprofile ohne Metallkern

			 70° shore
ADTP-1907	ADTP-25	ADSL-2579	ADHH-2094
		 80° shore	
AD-88	AD-502	ADTPHH-2396	ADTP-568
		 70° shore	
ADTP-946	ADTP-953	ADTPHH-2082	
		 80° shore	 70° shore
	AD-308	ADTPHH-2277	ADHH-2453
		 70° shore	
		ADTPHH-2532	
		 80° shore	
ADTP-1043		ADTPHH-2474	ADTP-2270

Abkürzungen der Standardfarben:















tr.: = naturtransparent
 wß.: = weiß
 b.: = beige
 br.: = braun
 gr.: = grau
 sw.: = schwarz

Abkürzungen der Werkstoffe:

AD: = Elastisch-PVC
 ADHH: = Halbhart-PVC
 ADTP: = TPE
 ADTPHH: = Halbhart-TPE
 ADSL: = Silicon-Kautschuk

Wichtige Hinweise:

Mindestmenge bei Lagerprofilen = 10 m, weitere Mengen müssen durch 5 m teilbar sein. Ab Mindestauftragswert von 30,- €, nach Typen gemischt, erfolgt Lieferung frei Haus, einschließlich Verpackung. Profile ohne Farbangebe auf Anfrage, Umtausch und Rückgabe ausgeschlossen. Bei Bedarf vor Bestellung bitte Muster anfordern. Technische Änderungen vorbehalten.

 ADTP-945	 ADTP-1507	95° shore  ADHH-735	 AD-742 sw.
 AD-1097	 ADTP-600 sw.	 AD-08	 ADTP-1880
 AD-1471	 AD-464	95° shore  ADHH-917 br., sw.	95° shore  ADHH-1284
 AD-1472	70° shore  ADTPHH-744 sw.	70° shore  ADTPHH-2065	 ADTP-1966
 AD-1473	 ADTP-101	95° shore  ADHH-852	95° shore  ADHH-1991
 ADTP-210 sw.	 ADTP-2332	85° shore  ADHH-1827	

Abkürzungen der Standardfarben:



























tr.: = naturtransparent
wß.: = weiß
b.: = beige
br.: = braun
gr.: = grau
sw.: = schwarz

























Abkürzungen der Werkstoffe:

AD: = Elastisch-PVC
ADHH: = Halbhart-PVC
ADTP: = TPE
ADTPHH: = Halbhart-TPE
ADSL: = Silicon-Kautschuk

Wichtige Hinweise:

Mindestmenge bei Lagerprofilen = 10 m, weitere Mengen müssen durch 5 m teilbar sein. Ab Mindestauftragswert von 30,- €, nach Typen gemischt, erfolgt Lieferung frei Haus, einschließlich Verpackung. Profile ohne Farbangebe auf Anfrage. Umtausch und Rückgabe ausgeschlossen. Bei Bedarf vor Bestellung bitte Muster anfordern. Technische Änderungen vorbehalten.

 AD-839	 ADTP-793	95° shore  ADHH-1413	70° shore  ADTPHH-1887
95° shore  ADHH-1438	sw. ADTP-2182 	ADTP-1587 	AD-324 
ADTP-176  sw.	ADTP-1888 	SZ-283-X 	gr. AD-325  sw.
70° shore  ADTPHH-1328	95° shore  ADHH-1414	sw. ADTP-790 	ADTP-2592 
95° shore  ADHH-1625	sw. ADHH-327 	sw. ADTP-1588 	ADTP-1447 
70° shore  ADTPHH-2438	ADTP-1819 	ADTP-1694 	gr. ADTPHH-2260 
70° shore  ADTPHH-2564	70° shore  ADTPHH-2328	ADTP-501 	br., sw. ADTP-2166 

80° shore  ADTPHH-2168	 AD-381	 ADTP-1609	 AD-743
 AD-1354	 ADTP-870	 ADTP-296	85° shore  ADHH-2593
 AD-848	 ADTP-894	 ADTP-1382	 ADTP-2066
 ADTP-2552	 AD-582	95° shore  ADHH-1474	 ADTP-1885
 ADTP-2170	95° shore  ADHH-1160	85° shore  ADHH-2451	 ADFP-2541
80° shore  ADTPHH-2285	 ADTP-1381	95° shore  ADHH-2156	 AD-627

Abkürzungen der Standardfarben:



















tr.: = naturtransparent
wß.: = weiß
b.: = beige
br.: = braun
gr.: = grau
sw.: = schwarz







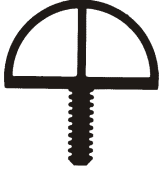

Abkürzungen der Werkstoffe:

AD: = Elastisch-PVC
ADHH: = Halbhart-PVC
ADTP: = TPE
ADTPHH: = Halbhart-TPE
ADSL: = Silicon-Kautschuk

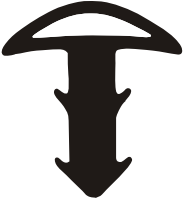
Wichtige Hinweise:

Mindestmenge bei Lagerprofilen = 10 m, weitere Mengen müssen durch 5 m teilbar sein. Ab Mindestauftragswert von 30,- €, nach Typen gemischt, erfolgt Lieferung frei Haus, einschließlich Verpackung. Profile ohne Farbangebe auf Anfrage. Umtausch und Rückgabe ausgeschlossen. Bei Bedarf vor Bestellung bitte Muster anfordern. Technische Änderungen vorbehalten.

			
ADTP-955	ADSL-2339	ADTP-2292	ADTP-830
			
ADTP-500	ADTP-2468	ADSL-2274	AD-905
			
ADTP-446	ADTP-1684		AD-989
			
ADTP-1676			
		70° shore 	
		ADHH-2452	AD-400
		95° shore 	
		ADHH-1334	AD-484
			95° shore 
ADSL-291	ADFP-2628	ADTP-1677	ADHH-1318

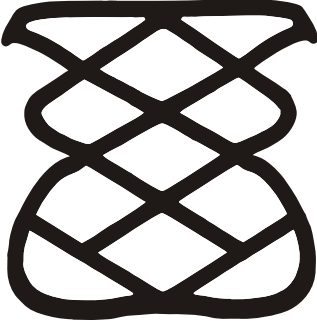
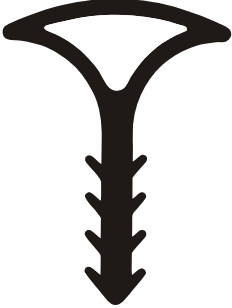
85° shore				
				
ADHH-1608		ADTP-1684	ADSL-2379	
95° shore				
				
ADHH-726	sw. ADFP-2541	ADTP-1389	AD-606	sw.
				
ADFP-2431	ADFP-2563		AD-606	sw.
		70° shore		
				
AD-709 (PVC) ADSL-709 (Silicon-Kautschuk)	ADTPHH-1830		AD-456	

Abkürzungen der Standardfarben:

tr.: = naturtransparent
 wß.: = weiß
 b.: = beige
 br.: = braun
 gr.: = grau
 sw.: = schwarz





Abkürzungen der Werkstoffe:

AD: = Elastisch-PVC
 ADHH: = Halbhart-PVC
 ADTP/ADFP: = TPE
 ADTPHH: = Halbhart-TPE
 ADSL: = Silicon-Kautschuk

Wichtige Hinweise:

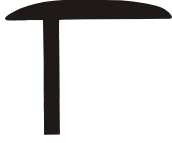
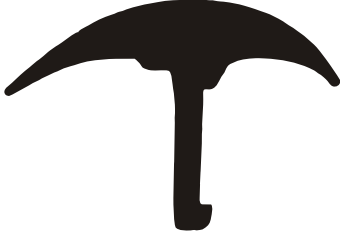







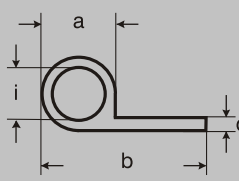

Mindestmenge bei Lagerprofilen = 10 m, weitere Mengen müssen durch 5 m teilbar sein. Ab Mindestauftragswert von 30,- €, nach Typen gemischt, erfolgt Lieferung frei Haus, einschließlich Verpackung. Profile ohne Farbangebe auf Anfrage. Umtausch und Rückgabe ausgeschlossen. Bei Bedarf vor Bestellung bitte Muster anfordern. Technische Änderungen vorbehalten.

















Sonderprofile

<p>95° shore</p>  <p>ADHH-869</p>			 <p>ADTP-1678</p>
 <p>ADTP-1599</p>			<p>ADFP-2568</p>
			 <p>ADTP-1446</p>

Keder-Profile

	<p>a = Außen-Ø i = Innen-Ø b = Breite d = Stärke Maße in mm</p>	<p>Werkstoff: TPE thermoplastischer Kautschuk (SEBS)</p>	<p>Alterungs-, witterungs-, licht- u. ozonbeständig, sowie kälteelastisch. Für geschlossene Dichtungsrahmen in den Ecken verschweißbar</p>
---	---	--	--

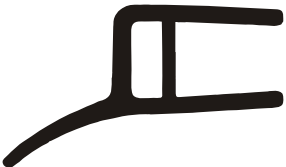
 SZ-259-X grau	<p>a = 8 i = 5 b = 16 d = 1,5</p>	 ADTP-2077 grau	<p>a = 6,0 i = 4,8 b = 21,0 d = 1,0</p>
 SZ-237-X grau	<p>a = 9 i = 6,6 b = 23,5 d = 2</p>	 ADTP-089 grau	<p>a = 6,5/6,0 i = 4 b = 25,5 d = 1</p>
 SZ-246-X grau	<p>a = 10 i = 7 b = 22 d = 2</p>	 ADTP-1870	<p>a = 5,3 hoch i = 2,5 b = 16,2 d = 1,6</p>
 SZ-233-X grau	<p>a = 12 i = 9 b = 25 d = 2</p>	 ADTP-519	<p>a = 6,8 hoch i = 3,5 b = 22 d = 1,8</p>
 ADTP-2221 schwarz	<p>a = 11 i = 7 b = 31 d = 2</p>		
 SZ-263-X grau	<p>a = 14 i = 11 b = 32 d = 2,5</p>		
 ADTP-2210 schwarz	<p>a = 5,5 i = 3,5 b = 43 d = 1,5</p>		

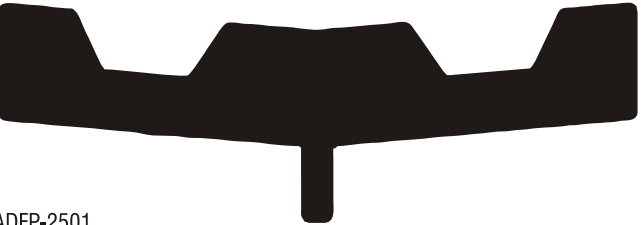
		
ADTP-1299	AD-475	sw. ADSL-972
		
AD-506	ADTP-1265	ADSL-980
80° shore		
		
ADTPHH-1929	ADHH-1053	ADSL-2434
		 selbstklebend
ADSL-969	ADHH-1083	ADTP-1697
		
ADTP-1696	ADFP-2502	ADFP-2383
		
ADFP-2507	sw. ADFP-2501	

Abkürzungen der Standardfarben:





















tr.:	= naturtransparent
wß.:	= weiß
b.:	= beige
br.:	= braun
gr.:	= grau
sw.:	= schwarz





Abkürzungen der Werkstoffe:

AD:	= Elastisch-PVC
ADHH:	= Halbhart-PVC
ADTP/ADFP:	= TPE
ADTPHH:	= Halbhart-TPE
ADSL:	= Silicon-Kautschuk

Wichtige Hinweise:

Mindestmenge bei Lagerprofilen = 10 m, weitere Mengen müssen durch 5 m teilbar sein. Ab Mindestauftragswert von 30,- €, nach Typen gemischt, erfolgt Lieferung frei Haus, einschließlich Verpackung. Profile ohne Farbangebe auf Anfrage. Umtausch und Rückgabe ausgeschlossen. Bei Bedarf vor Bestellung bitte Muster anfordern. Technische Änderungen vorbehalten.

 <p>AD-979</p>	 <p>AD-576</p>		 <p>ADTP-1569</p>
 <p>AD-978</p>	 <p>AD-1325</p>		<p>85° shore</p>  <p>ADHH-1069</p>
 <p>ADTP-1379</p>	 <p>ADTP-2405</p>		 <p>ADSL-1017 selbstklebend</p>
 <p>ADTPHH-1842</p>		<p>70° shore</p>  <p>AD-1582</p>	
 <p>ADTP-1500</p>	<p>85° shore</p>  <p>ADHH-1363</p>	<p>85° shore</p>  <p>ADHH-1312</p>	<p>85° shore</p>  <p>ADHH-1082</p>
 <p>ADTP-2086</p>	<p>85° shore</p>  <p>ADHH-1366</p>	<p>85° shore</p>  <p>ADHH-1367</p>	
 <p>ADTP-1458</p>	<p>85° shore</p>  <p>ADHH-1638 a</p>		 <p>ADTP-1381</p>

 <p>ADTP-445</p>	 <p>ADTP-2159</p>	 <p>ADTP-2430</p>	 <p>ADTP-2268</p>

Abkürzungen der Standardfarben:

tr.: = naturtransparent
 wß.: = weiß
 b.: = beige
 br.: = braun
 gr.: = grau
 sw.: = schwarz

Abkürzungen der Werkstoffe:

AD: = Elastisch-PVC
 ADHH: = Halbhart-PVC
 ADTP: = TPE
 ADTPHH: = Halbhart-TPE
 ADSL: = Silicon-Kautschuk

Wichtige Hinweise:

Mindestmenge bei Lagerprofilen = 10 m, weitere Mengen müssen durch 5 m teilbar sein. Ab Mindestauftragswert von 30,- €, nach Typen gemischt, erfolgt Lieferung frei Haus, einschließlich Verpackung. Profile ohne Farbangebe auf Anfrage. Umtausch und Rückgabe ausgeschlossen. Bei Bedarf vor Bestellung bitte Muster anfordern. Technische Änderungen vorbehalten.

Zum Austauschen



<p style="text-align: center;">H</p> <p>ADTP-965</p>	<p style="text-align: center;">H</p> <p>ADSL-527</p>		
<p style="text-align: center;">4</p> <p>AD-255</p>	<p style="text-align: center;">H</p> <p>ADSL-528 Silicon-Kautschuk</p>		
<p style="text-align: center;">H</p> <p>ADSL-1026 Silicon-Kautschuk</p>	<p style="text-align: center;">H</p> <p>ADTP-1708</p>	<p style="text-align: center;">H</p> <p>ADFP-2571</p>	

Abkürzungen der Standardfarben:

tr.: = naturtransparent
 wß.: = weiß
 b.: = beige
 br.: = braun
 gr.: = grau
 sw.: = schwarz









Abkürzungen der Werkstoffe:

AD: = Elastisch-PVC
 ADHH: = Halbhart-PVC
 ADTP: = TPE
 ADTPHH: = Halbhart-TPE
 ADSL: = Silicon-Kautschuk

Wichtige Hinweise:

Mindestmenge bei Lagerprofilen = 10 m, weitere Mengen müssen durch 5 m teilbar sein. Ab Mindestauftragswert von 30,- €, nach Typen gemischt, erfolgt Lieferung frei Haus, einschließlich Verpackung. Profile ohne Farbangebe auf Anfrage. Umtausch und Rückgabe ausgeschlossen. Bei Bedarf vor Bestellung bitte Muster anfordern. Technische Änderungen vorbehalten.

Sonderprofile

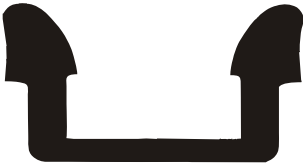
80° shore  ADTPHH-2318	 ADHH-2076	 ADTP-2177	95° shore  ADHH-1380
AD-1339 a (PVC) ADTP-1911 (TPE)	 ADTP-2407	 ADTP-2093	 AD-863
70° shore  ADTPHH-2491		85° shore  ADHH-2327	
	 ADTP-2543		

Abkürzungen der Standardfarben:





tr.: = naturtransparent
 wß.: = weiß
 b.: = beige
 br.: = braun
 gr.: = grau
 sw.: = schwarz

Abkürzungen der Werkstoffe:





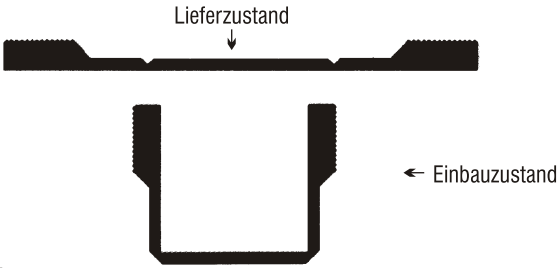
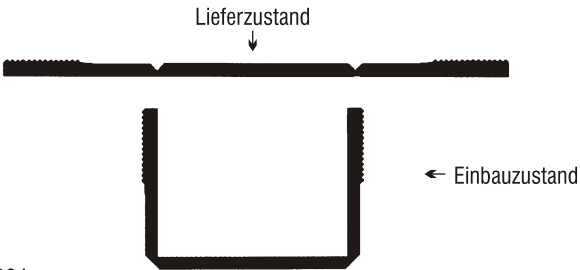











AD: = Elastisch-PVC
 ADHH: = Halbhart-PVC
 ADTP: = TPE
 ADTPHH: = Halbhart-TPE
 ADSL: = Silicon-Kautschuk

Wichtige Hinweise:

Mindestmenge bei Lagerprofilen = 10 m, weitere Mengen müssen durch 5 m teilbar sein. Ab Mindestauftragswert von 30,- €, nach Typen gemischt, erfolgt Lieferung frei Haus, einschließlich Verpackung. Profile ohne Farbangebe auf Anfrage. Umtausch und Rückgabe ausgeschlossen. Bei Bedarf vor Bestellung bitte Muster anfordern. Technische Änderungen vorbehalten.

	 <p>ADTP-1398</p>	
	 <p>ADTP-1810</p>	
	 <p>ADTP-2363</p>	
	 <p>ADTP-2364</p>	
	 <p>ADTPHH-2490</p>	

U-Profile für Sonderkonstruktionen

70° shore  ADTPHH-1947	 AD-1132	 ADTP-532	80° shore  ADTPHH-2611
95° shore  ADHH-1128	90° shore  ADHH-859	70° shore  ADTPHH-2458	sw. ADTP-2301 
 ADTP-1350	 AD-862	 ADTP-1514	70° shore  ADTPHH-2634
70° shore  ADTPHH-1691 a	 ADFP-2562		
 AD-1326	 ADTP-2362		
	70° shore  ADTPHH-384	gr.	

Abkürzungen der Standardfarben:

tr.:	= naturtransparent
wß.:	= weiß
b.:	= beige
br.:	= braun
gr.:	= grau
sw.:	= schwarz













Abkürzungen der Werkstoffe:

AD:	= Elastisch-PVC
ADHH:	= Halbhart-PVC
ADTP:	= TPE
ADTPHH:	= Halbhart-TPE
ADSL:	= Silicon-Kautschuk

Wichtige Hinweise:

Mindestmenge bei Lagerprofilen = 10 m, weitere Mengen müssen durch 5 m teilbar sein. Ab Mindestauftragswert von 30,- €, nach Typen gemischt, erfolgt Lieferung frei Haus, einschließlich Verpackung. Profile ohne Farbangebe auf Anfrage. Umtausch und Rückgabe ausgeschlossen. Bei Bedarf vor Bestellung bitte Muster anfordern. Technische Änderungen vorbehalten.

U-Profile für Sonderkonstruktionen

70° shore  ADTPHH-2325	70° shore  ADHH-2075	80° shore  ADTPHH-1913	 ADTP-1478
70° shore  ADTPHH-2299	 ADTP-2092	 ADTP-953	 ADFP-2384
70° shore  ADTPHH-1988		 AD-298	
70° shore  ADTPHH-2496		 AD-531	
		 AD-752	

U-Profile für Sonderkonstruktionen

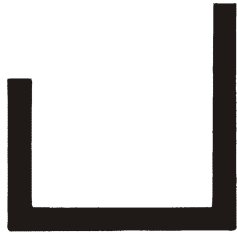

ADTP-1135

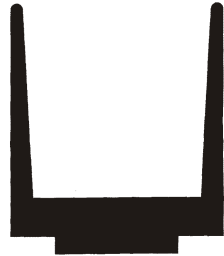

ADTP-2272

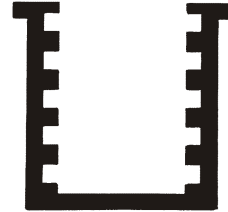

ADTP-2397

Abkürzungen der Standardfarben:

tr.: = naturtransparent
 wß.: = weiß
 b.: = beige
 br.: = braun
 gr.: = grau
 sw.: = schwarz

















Abkürzungen der Werkstoffe:

AD: = Elastisch-PVC
 ADHH: = Halbhart-PVC
 ADTP: = TPE
 ADTPHH: = Halbhart-TPE
 ADSL: = Silicon-Kautschuk

Wichtige Hinweise:









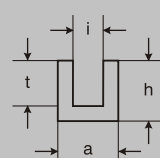





Mindestmenge bei Lagerprofilen = 10 m, weitere Mengen müssen durch 5 m teilbar sein. Ab Mindestauftragswert von 30,- €, nach Typen gemischt, erfolgt Lieferung frei Haus, einschließlich Verpackung. Profile ohne Farbangebe auf Anfrage. Umtausch und Rückgabe ausgeschlossen. Bei Bedarf vor Bestellung bitte Muster anfordern. Technische Änderungen vorbehalten.

U-Profile für Trockenverglasung und Sonderkonstruktionen

 ADTP-63	sw. AD-2184 		 ADTP-1562
 AD-1990	AD-2264 		85° shore  ADHH-851
 AD-1365	90° shore ADHH-877 		
 ADTP-1564	AD-716 		
	ADTP-1388 		
85° shore  ADHH-2330			 ADTP-2321
 AD-752		 ADTP-2531	 AD-629









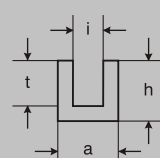





Gummi-U-Profile

	<p>i = innen a = außen h = hoch t = tief</p>	<p>Werkstoff: TPE thermoplastischer Kautschuk (SEBS)</p>	<p>Alterungs-, witterungs-, licht- u. ozonbeständig, sowie kälteelastisch. Für geschlossene Dichtungsrahmen in den Ecken verschweißbar</p>
---	--	--	--

 ADTP-1100 sw.	<p>i = 1 a = 3 h = 8 t = 6</p>	 ADTP-011 sw.	<p>i = 1,7 a = 4,8 h = 10 t = 8,5</p>
 ADTP-1101 sw.	<p>i = 1 a = 3 h = 10 t = 8</p>	 ADTP-1107 sw.	<p>i = 1,8 a = 5 h = 10 t = 8</p>
 ADTP-1102 sw.	<p>i = 1,2 a = 3,5 h = 8 t = 6</p>	 ADTP-1108 sw.	<p>i = 1,8 a = 5 h = 12 t = 10</p>
 ADTP-1103 sw.	<p>i = 1,2 a = 3,5 h = 10 t = 8</p>	 ADTP-1109 sw.	<p>i = 2 a = 5 h = 10 t = 8</p>
 ADTP-1104 sw.	<p>i = 1,5 a = 4 h = 8 t = 6</p>	 ADTP-1110 sw.	<p>i = 2 a = 5 h = 12 t = 10</p>
 ADTP-1105 sw.	<p>i = 1,5 a = 4 h = 10 t = 8</p>	 ADTP-1111 sw.	<p>i = 2,5 a = 6 h = 10 t = 8</p>
 ADTP-1106 sw.	<p>i = 1,5 a = 4 h = 12 t = 10</p>	 ADTP-1112 sw.	<p>i = 2,5 a = 6 h = 12 t = 10</p>





Gummi-U-Profile

	<p>i = innen a = außen h = hoch t = tief</p>	<p>Werkstoff: TPE thermoplastischer Kautschuk (SEBS)</p>	<p>Alterungs-, witterungs-, licht- u. ozonbeständig, sowie kälteelastisch. Für geschlossene Dichtungsrahmen in den Ecken verschweißbar</p>
---	--	--	--

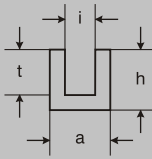
 ADTP-1113 sw.	<p>i = 3 a = 6 h = 10 t = 8</p>	 ADTP-1119 sw.	<p>i = 6 a = 10 h = 12 t = 10</p>
 ADTP-1114 sw.	<p>i = 3 a = 6 h = 12 t = 10</p>	 ADTP-750 sw.	<p>i = 7,5 a = 10,5 h = 10 t = 8,5</p>
 ADTP-1115 sw.	<p>i = 4 a = 8 h = 10 t = 8</p>	 ADTP-1133 sw.	<p>i = 6 a = 10 h = 15 t = 13</p>
 ADTP-1116 sw.	<p>i = 4 a = 8 h = 12 t = 10</p>	 ADTP-2562 sw.	<p>i = 7 a = 11 h = 17 t = 15</p>
 ADTP-1125 sw.	<p>i = 4 a = 10 h = 12 t = 9</p>	 ADTP-1120 sw.	<p>i = 8 a = 12 h = 12 t = 10</p>
 ADTP-1117 sw.	<p>i = 5 a = 9 h = 12 t = 10</p>	 ADTP-1134 sw.	<p>i = 10 a = 13 h = 14 t = 12,5</p>
 ADTP-1118 sw.	<p>i = 6 a = 10 h = 12 t = 8,5</p>	 ADTP-1121 sw.	<p>i = 10 a = 15 h = 12 t = 9</p>

Gummi-U-Profile

	<p>i = innen a = außen h = hoch t = tief</p>	<p>Werkstoff: TPE thermoplastischer Kautschuk (SEBS)</p>	<p>Alterungs-, witterungs-, licht- u. ozonbeständig, sowie kälteelastisch. Für geschlossene Dichtungsrahmen in den Ecken verschweißbar</p>
---	--	--	--

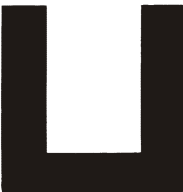
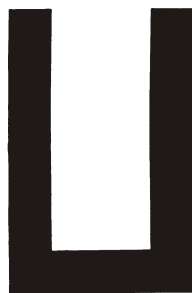
 ADTP-1124 sw.	<p>i = 10 a = 15 h = 15 t = 9</p>		
 ADTP-1130 sw.	<p>i = 11 a = 17 h = 18,5 t = 15</p>		
 ADTP-1122 sw.	<p>i = 12 a = 18 h = 15 t = 12</p>		
 ADTP-1123 sw.	<p>i = 12 a = 18 h = 18 t = 15</p>		
 ADTP-1127 sw.	<p>i = 12 a = 22 h = 20 t = 15</p>		
 ADTP-1126 sw.	<p>i = 12,4 a = 24 h = 25 t = 19,2</p>	 ADTP-1131 sw.	<p>i = 13 a = 24 h = 38 t = 32,5</p>



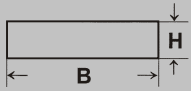









Gummi-Vierkant-Profile

	<p>Nennmaße: Höhe x Breite Maße in mm</p>	<p>Werkstoff: TPE thermoplastischer Kautschuk (SEBS)</p>	<p>Alterungs-, witterungs-, lichtriß- u. ozonbeständig, sowie kälteelastisch. Für geschlossene Dichtungsrahmen in den Ecken verschweißbar</p>
---	---	--	---











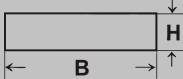





AD-1137 sw.

2 x 70









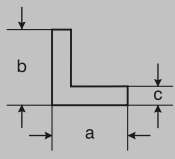

<p>Werkstoff: Silicon-Kautschuk</p> 	<p>0,6 x 13</p>		<p>3 x 10</p>
<p>ADSL-2580</p>		<p>ADTP-1144 sw.</p>	
	<p>2 x 5</p>		<p>3 x 20</p>
<p>ADTP-1139 sw.</p>		<p>ADTP-1138</p>	
	<p>2 x 8</p>		<p>4 x 8</p>
<p>ADTP-1140 sw.</p>		<p>ADTP-1145 sw.</p>	
	<p>2 x 10</p>		<p>4 x 10</p>
<p>ADTP-1141 sw.</p>		<p>ADTP-1146 sw.</p>	
	<p>3 x 5</p>		<p>4 x 15</p>
<p>ADTP-1142 sw.</p>		<p>ADTP-1147 sw.</p>	
	<p>3 x 8</p>		<p>4 x 20</p>
<p>ADTP-1143 sw.</p>		<p>ADTP-1148 sw.</p>	

Gummi-Vierkant-Profile

	Nennmaße: Höhe x Breite Maße in mm	Werkstoff: TPE thermoplastischer Kautschuk (SEBS)	Alterungs-, witterungs-, lichtriß- u. ozonbeständig, sowie kälteelastisch. Für geschlossene Dichtungsrahmen in den Ecken verschweißbar
 AD-1158 = PVC – ADTP-1149 = TPE sw.	5 x 10	 ADTP-1153 sw.	4 x 4
 ADTP-1150 sw.	5 x 15	 ADTP-1154 sw.	5 x 5
Werkstoff: Silicon-Kautschuk			
 ADSL-1163 sw.	5 x 17	 ADTP-1155 sw.	6 x 6
 ADTP-1151 sw.	5 x 20	 ADTP-1156 sw.	8 x 8
 ADTP-1152 sw.	5 x 30	 ADTP-1157 sw.	10 x 10
 ADTP-1161 sw.	5 x 40	 ADTP-1159 sw.	12 x 10
 ADTP-1162 sw.	6 x 10		

Gummi-Winkel-Profile

		<p>Werkstoff: TPE thermoplastischer Kautschuk (SEBS)</p>	<p>Alterungs-, witterungs-, lichtriß- u. ozonbeständig, sowie kälteelastisch. Für geschlossene Dichtungsrahmen in den Ecken verschweißbar</p>
---	--	--	---

 ADTP-1176	<p>a = 9 b = 5,5 c = 1</p>	 ADTP-1183	<p>a = 20 b = 20 c = 4</p>
 ADTP-1178	<p>a = 10 b = 10 c = 2</p>	 ADTP-1185	<p>a = 25 b = 25 c = 5</p>
 ADTP-1179	<p>a = 12 b = 12 c = 2</p>		
 ADHH-1177	<p>a = 14,5 b = 6,5 c = 1,5</p>	 ADTP-1186	<p>a = 30 b = 30 c = 2</p>
 ADTP-1180	<p>a = 15 b = 15 c = 2,5</p>		
 ADTP-1181	<p>a = 20 b = 20 c = 2</p>		
 ADTP-1182	<p>a = 20 b = 20 c = 3</p>		

Gummi-Maschinenschläuche

ohne Gewebeeinlage



	<p>Nennmaße: Außen Ø x Innen Ø Maße in mm</p>	<p>Werkstoff: TPE thermoplastischer Kautschuk (SEBS)</p>	<p>Alterungs-, witterungs-, licht- und ozon- beständig sowie kälteelastisch.</p>
--	---	--	--

<p>ADTP-1570</p> <p>sw.</p>	<p>4 x 2</p>	<p>ADTP-1170</p> <p>sw.</p>	<p>8 x 4</p>
<p>ADTP-1167</p> <p>sw.</p>	<p>5 x 3</p>	<p>ADTP-1171</p> <p>sw.</p>	<p>8 x 5</p>
<p>ADTP-1168</p> <p>sw.</p>	<p>6 x 3</p>		
<p>ADSL-1168</p>	<p>6 x 3</p> <p>Silicon-Kautschuk</p>	<p>ADTP-1164</p> <p>sw.</p>	<p>9 x 7</p>
<p>ADTP-1169</p> <p>sw.</p>	<p>7 x 4</p>		
<p>ADTP-1055</p> <p>sw.</p>	<p>7 x 5</p>	<p>ADTP-1172</p> <p>sw.</p>	<p>10 x 6</p>

Gummi-Maschinenschläuche

ohne Gewebeeinlage







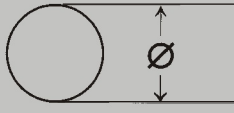

	<p>Nennmaße: Außen Ø x Innen Ø Maße in mm</p>	<p>Werkstoff: TPE thermoplastischer Kautschuk (SEBS)</p>	<p>Alterungs-, witterungs-, licht- und ozon- beständig sowie kälteelastisch.</p>
--	---	--	--

 ADTP-1173 sw.	<p>12 x 7</p>	<h2>Schlauchartige Sonderprofile</h2>	
 ADTP-1174 sw. ca. 80° shore	<p>12 x 8</p>	 ADTP-1444	<p>5,5 x 2 mm</p>
 ADTPHH-1165 sw.	<p>12 x 5,5</p>	 ADTP-824	<p>9,5 x 4 mm mit Schlitz</p>
 ADTPHH-1166 sw. ca. 80° shore	<p>17 x 8</p>	 ADTP-858	<p>Innen Ø asymmetrisch 9,5 x 4,2 mm mit Schlitz</p>

Gummi-Rundschnüre

	<p>Nennmaß: Schnur-Ø Maß in mm</p>	<p>Werkstoff: TPE thermoplastischer Kautschuk (SEBS)</p>	<p>Alterungs-, witterungs-, lichtriß- und ozon- beständig sowie kälteelastisch.</p>
---	--	--	---

 ADTP-1197 sw.	<p>3</p>		
 ADTP-1192 sw.	<p>4</p>		
 ADTP-1193 sw.	<p>5</p>		
 ADTP-1194 sw.	<p>6</p>		
 ADTP-1195 sw.	<p>8</p>		
 ADTP-1196 sw.	<p>10</p>		